



E āhei ana rānei ki te tohatoha i tēnei pukapuka ngohe? **ĀE**

E āhei ana rānei ki te hoko atu i tēnei pukapuka ngohe? **KĀO**

E āhei ana rānei ki te whakarerekē ki te rawe i tēnei pukapuka ngohe? **KĒI ĒTAHI WĀHANGA ĀE.**

© Te Papa. Hāunga te moko Te Papa me ngā whakaahua, kua raihanatia tēnei pukapuka ngohe Te Rā o Waitangi e Te Papa Tongarewa i raro i te Raihana Creative Commons Tautohu Matatiki Arumoni Kore 4.0 ā-Ao.

Me mōhio, kāore e kapi i tēnei raihana te whakamahi anō, te urutaunga rānei o te moko Te Papa i waho i te horopaki o tēnei pukapuka mahi. Me āta tuhi taua tautohu matatiki, kāore e whakaaetia kia tāruatia te moko Te Papa.

Ki te whakaputa, tohatoha, whakahōrapa rānei i tēnei mahi ki te iwi whānui mā te āhua kē me te kore e urutau, me whakamahi rawa i tēnei tautohu matatiki ki Te Papa:

Mātāpuna: "Te Papa Tongarewa (Te Papa) tepapa.nz/WaitangiDayActivityBook kua raihanatia e Te Papa hei whakamahinga anō i raro i te Raihana Creative Commons Tautohu Matatiki Arumoni Kore 4.0 ā-Ao."

Ki te urutau koe i tēnei mahi, ahakoa he aha te momo urutau, ki te whakauru rānei ki roto i tētahi kohinga, ka whakaputa, ka tohatoha, ka whakahōrapa rānei i taua urutaunga, kohinga rānei ki te iwi whānui mā te āhua kē, me whakamahi i tēnei tautohu matatiki ki Te Papa:

"Kei roto i tēnei mahi te 'pukapuka ngohe Te Rā o Waitangi' a Te Papa Tongarewa, kua raihanatia e Te Papa hei whakamahinga anō i raro i te Raihana Creative Commons Tautohu Matatiki Arumoni Kore 4.0 ā-Ao."

E tūmanako nei mātou ki te mōhio ki te āhua o tā koutou whakamahi i tēnei pukapuka mahi, ki ō whakaaro hoki. Ī-mērātia mai ki learning@tepapa.govt.nz

Te Rā o Waitangi Pukapuka mahi

tepapa.nz/WaitangiDayActivityBook



Huri te tau ka tū te rā o Waitangi i te 6 o Pēpuere.

Ko tēnei te rā e hoki ai te mahara ki ngā hainatanga tuatahitanga o te Tiriti o Waitangi, he mea whakarite i waenganui i te Pākehā me te Māori i te 6 o Pēpuere, 1840

Kātahi ka haria haeretia te Tiriti huri noa o Aotearoa, nō te Hepetema, 1840 ka oti te 500 ngā tohu o ngā rangatira te haina.

Ka whakaritea e te Tiriti ki te tiaki i te whenua Māori, ā, me te whakaaetanga a te Kuini o Ingarangi (te Karauna) ki te tuku i ngā tikanga rite tahi a te Pākehā ki te Māori.

Ko te Tiriti he tohu kotahitanga o te iwi Pākehā me te iwi Māori. Heoi, kāhore i pai te tiaki tonu i ngā wāhanga o te Tiriti, ā, ko ngā kupu pērā i te kāwanatanga me te tino rangatiratanga te take nui kīhai anō i eke te noho tahitanga a te Māori me te Karauna.



Tēnā, kōwhiria kia toru ngā tae e whakaatu ana i te āhua o tō whakahono i ēnei kupu, tohu rānei. Tērā pea he tino tae tino pai ēnei e toru ki a koe!



Tēnā, whakamahia ō ake tae ō ake tohu tino pai ki a koe ki te waihanga i tō kara.



Ināianeī, kei ō ringa te mahi waihanga kara nāu ake!

He ngāwari pea te āhua o ngā tohu engari he tikanga nui tonu ō ngā tae.











Tuatahi, tuhia kia toru ngā kupu, kia toru rānei ngā tohu he mea ahu mai i ō whakaaro inā whakaaro koe ki tō KĀINGA ki 'Aotearoa'nei.

1	2	3
---	---	---

Nā, tuhia kia toru ngā kupu, kia toru rānei ngā tohu he mea ahu mai i ō whakaaro inā whakaaro koe ki te kupu WĀHI.

1	2	3
---	---	---

Mā tēnei pukapuka mahi, ka tirohia:

-  ngā mahi i a koe i te rā o Waitangi
-  ngā take i hua ake ai te hainatanga o te Tiriti
-  kei hea a Waitangi
-  ngā kōrero tika, ngā kōrero teka mō te Tiriti
-  te āhua o te tuhi a te Māori me te mana o ngā kupu
-  te āhua o ngā hainatanga o te Tiriti
-  ngā pānga mai o te hainatanga o te Tiriti
-  ngā tikanga o ngā kara ka kitea i te rā o Waitangi
-  te waihangatanga i tō ake kara.



Ka aha koe i te rā o Waitangi?

Kaurukutia ngā pikitia e whakaatu ana i ngā mahi i a koe.



Haere ki tētahi hui whakanui

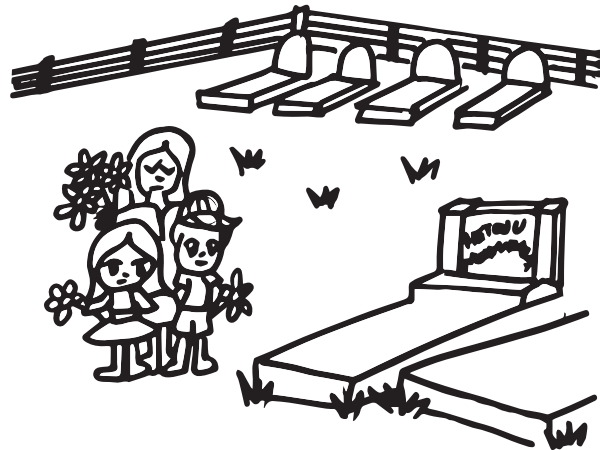

Maumahara i ngā mate



Noho ki te kāinga

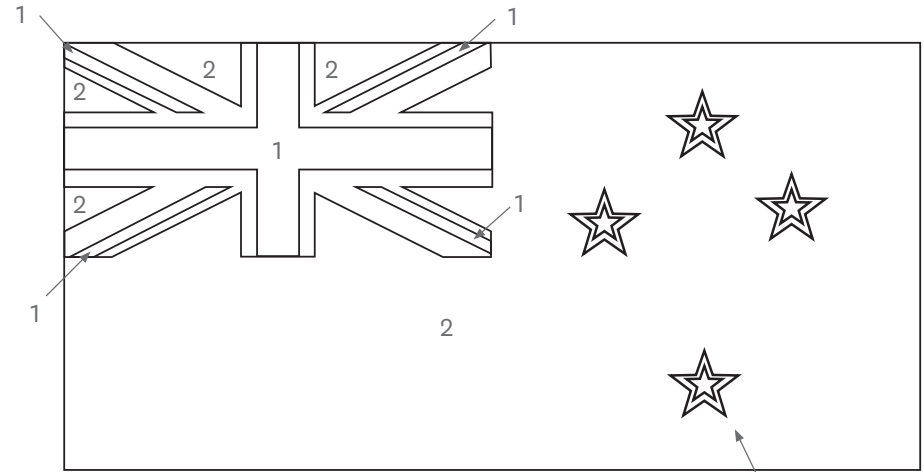

Te Haki o Aotearoa

1 (o waenga o ngā whetū)

Mai anō i te tau 1902 ko te haki o Aotearoa he mea e mōhioia ana puta noa i te ao.

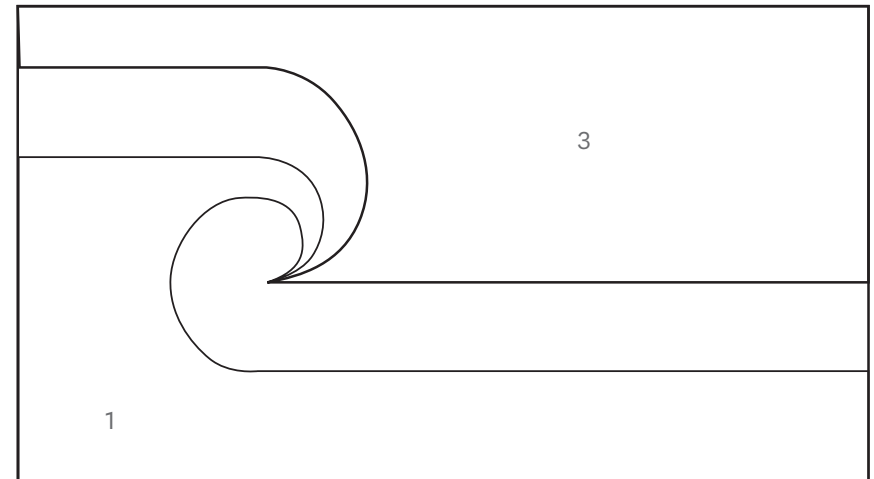

Te Kara Tino Rangatiratanga

Nō te tau 1990 koinei te kara i eke i tētahi whakataetae waihanga kara. Hei ētahi rā ka whakatere tahi ki te haki o Aotearoa he mea e tohu ana i te tino rangatiratanga o te iwi Māori i raro i te Tiriti o Waitangi.

I ia rā o Waitangi ka whakarere e Te Papa Tongarewa i ngā kara e toru. Kaurukutia ngā kara nei ki ngā tae tika.

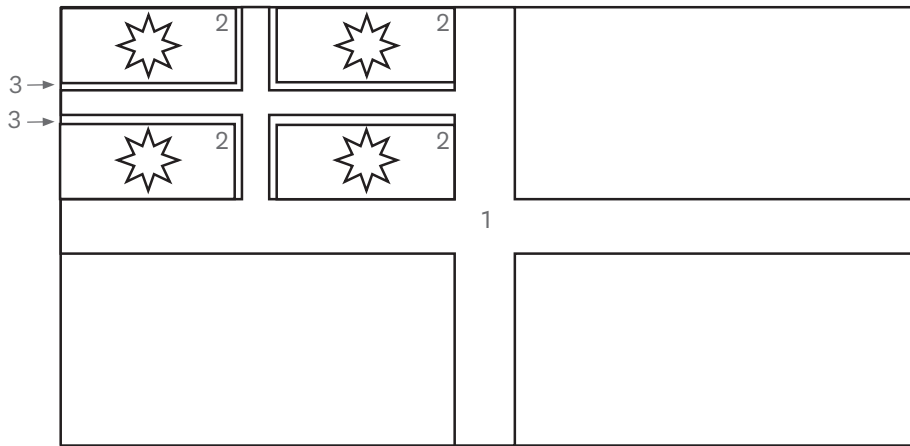

Te Kara - Te Whakaminenga o Ngā Hapū

Nō te tau 1834 he mea kōwhiri tēnei kara nā ngā rangatira o te Taitokerau i Waitangi. He tikanga rā e mana ai te mahi tauhokohoko mā runga i ō rātou kaipuke puta noa i ngā moana o te ao.

He mea whakamana tonu hoki tēnei kara nā te Kīngi o Ingarangi.

He meka matua! I te tūwheratanga o Te Papa, i ia tau, ka haere mai ngā uri o Pūmuka te rangatira ki tō rātou haki, ōrite nei te ingoa. He hokinga mahara, he hokinga wairua.

Kei te paetukutuku o Te Papa ētahi atu kōrerō: tepapa.nz

Haere ki tātahi



Haere ki te marae



Mahi hākinakina

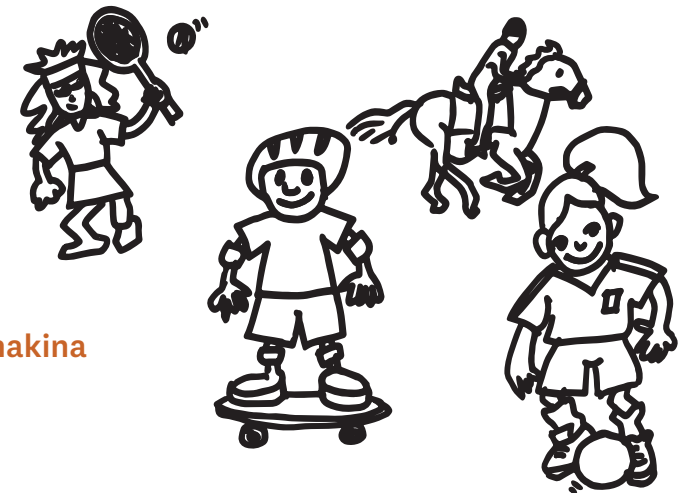

Pānuihia tēnei wā taka ka kitea ai ngā take i te takanga o te wā i hua ake ai te hainatanga o te Tiriti o Waitangi.

1814
Ka tae mai ngā mihinare tuatahi ki Nu Tirani.

1805
Ka haere a Te Pahi ki Poihākēna ki te whakarite i ngā mahi tauhokohoko.

1791-1792
Ka tīmata te taenga atu o ngā kaipatu tohorā me te mahi tauhokohoko ki Poihākēna, Anitereiria.

1772
Ka tae mai a Marion Du Fresne ki Pēwhairangi.

1769, 12 Hakihea
Ka tae mai te St Jean Baptiste ki te Hokianga, he kaipuke nā Kāpene Jean François Marie de Surville.

1800
Kei te takiwā o te 100,000-120,000 te tokomaha o te Māori.

1795-1830
Kei te takiwā o te 1,000 ngā kaipuke patu kekeno, patu tohorā ka toro mai ki ngā tai o Nu Tirani



1769, 6 Whiringa-ā-nuku
Ka ū mai a Kāpene James Cook me tōna kaipuke a te Endeavour ki Nu Tirani.

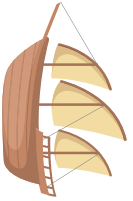

ngā tau 127

1642, 13 Hakihea
Ko te rā e mōhiohia ana o te kītenga tuatahi o Te Ika-a-Māui nā tētahi Pākehā, nā Abel Tasman.



NGĀ KŌRERO MŌ TE MĀORI I MUA O TE TŪTAKINGA KI TE PĀKEHĀ

Nō te wā i hainatia te Tiriti e te Māori, kāore rātou i tino mōhio ki ōna pānga ki runga i ngā uri whakaheke. Kei raro nei ētahi o ngā pānga kei runga tonu i ngā uri i tēnei rā.



He pānga atu anō e mōhio nā koe? Tāngia ēnā ki roto ki ngā porowhita kei raro nei.

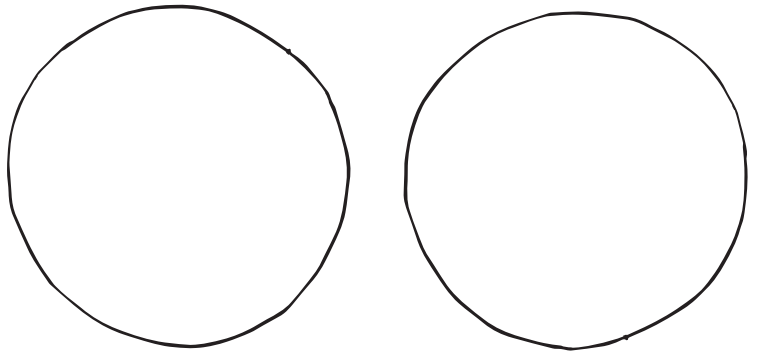

NGĀ KŌREPO MŌ NU TIRANI I MURI O TE TIRITI

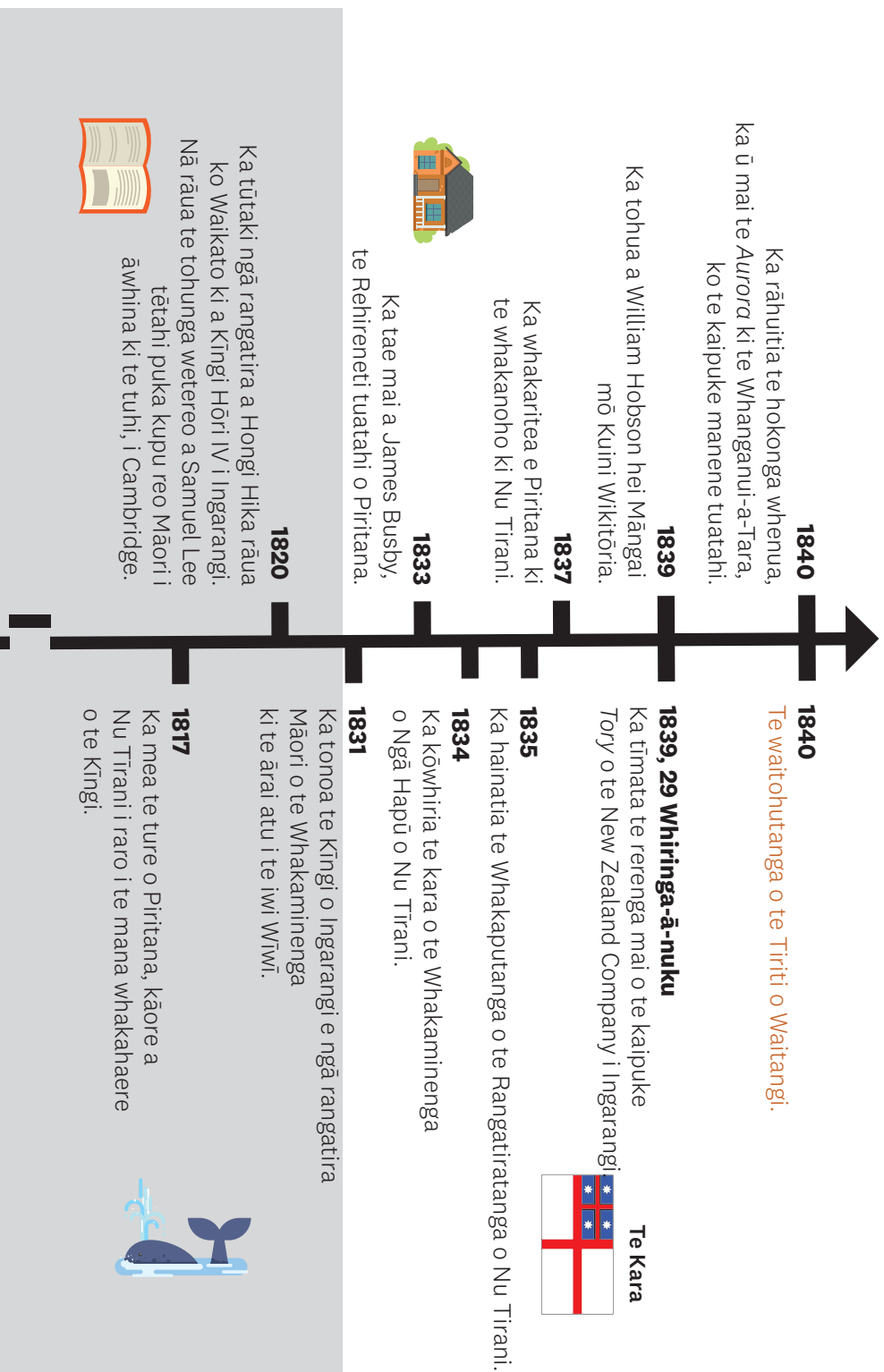

I te wā i hainatia te Tiriti e te Māori, he tohu te tuhinga ā te nuinga, he mana tō ēnā tohu ki a rātou. Ko ētahi i tuhia mai he wāhanga nō ō rātou moko kanohi, ko ētahi atu he tohu nō te taiao.

Kei raro nei ētahi ka kitea o runga i te Tiriti o Waitangi. Ka pēhea te āhua o tō haina i te Tiriti.

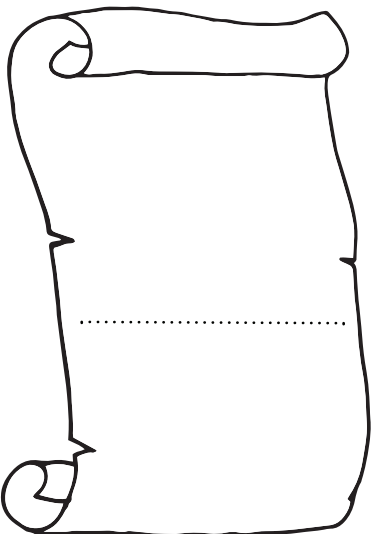

Parakitihi ki konei i mua i tō hainatanga o te pepa:

Whakaahua: He wāhanga nō [Te Tiriti o Waitangi](#), 8 Aperira 1840. [CC BY 2.0](#). Nā Te Rua Mahara o te Kāwanatanga te manatā i Flickr

Ko Waitangi tētahi wāhi o Aotearoa. Ka taea e koe te kite kei hea rā i tēnei mahere.



Heoi, kāhore anō kia oti te mahere! Tuhia ngā pere ki ngā wāhi tino pai ki a koe.

- Tō kāinga
- Tō wāhi hararei tino pai ki a koe?
- Tō maunga
- Tō wāhi nō reira ō mātua
- Tō wāhi e tino pai ana koe ki te haere
- Tō tātou tāone matua

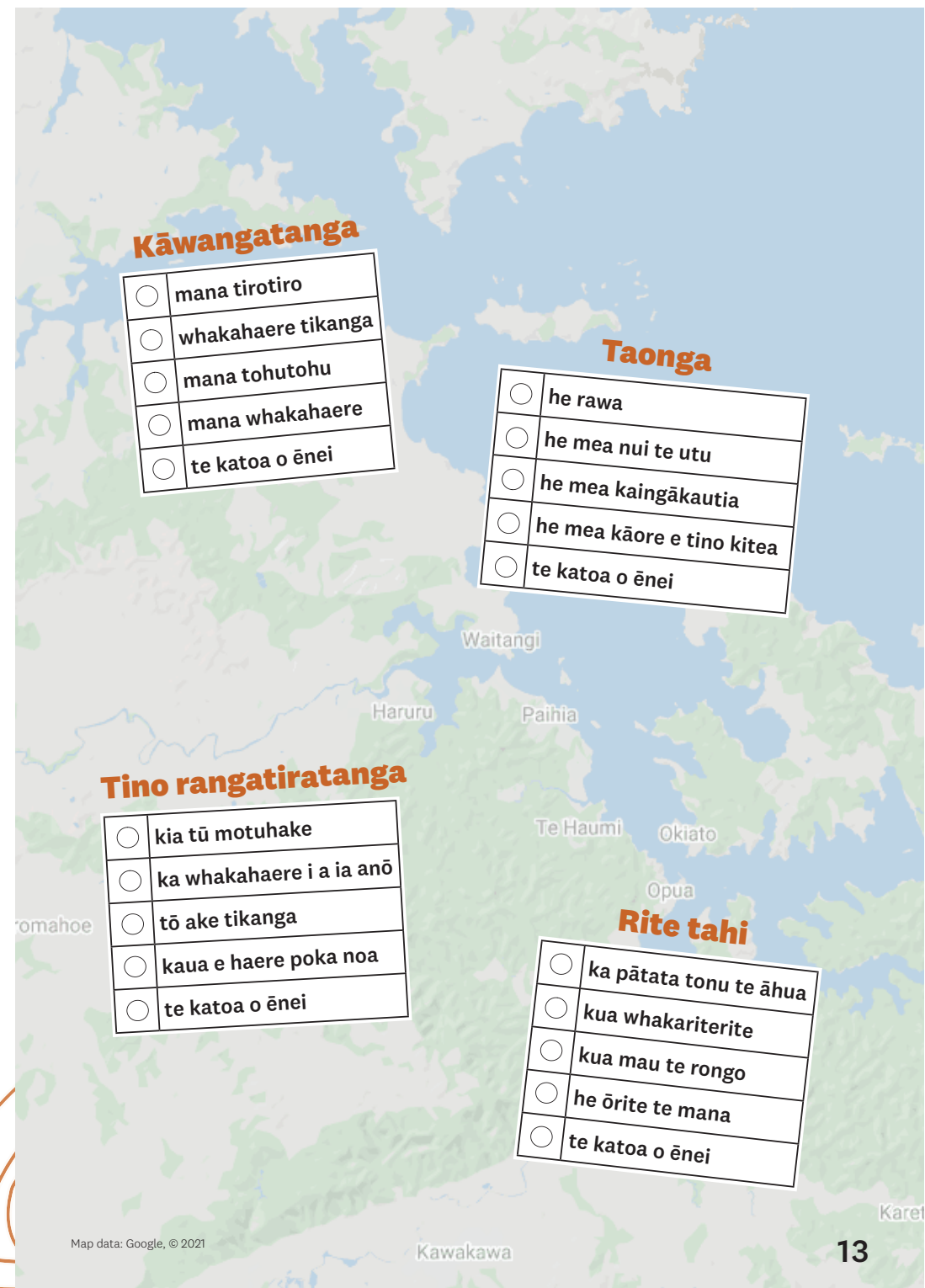

He mea whakawhiti te Tiriti o Waitangi mai i te reo Pākehā ki te reo Māori. He Pākehā, he tangata reo rua, ao rua te kaiwhakawhiti nāna i whakamāori, he mihingare hoki. Mo ētahi o ngā kupu o ia reo, kāore he kupu taurite.

Kei raro nei ētahi kupu i te Tiriti o Waitangi. Kaurukutia ngā porohita o ngā kupu taurite e whakaatu ana i te mārāma o te kupu matua.

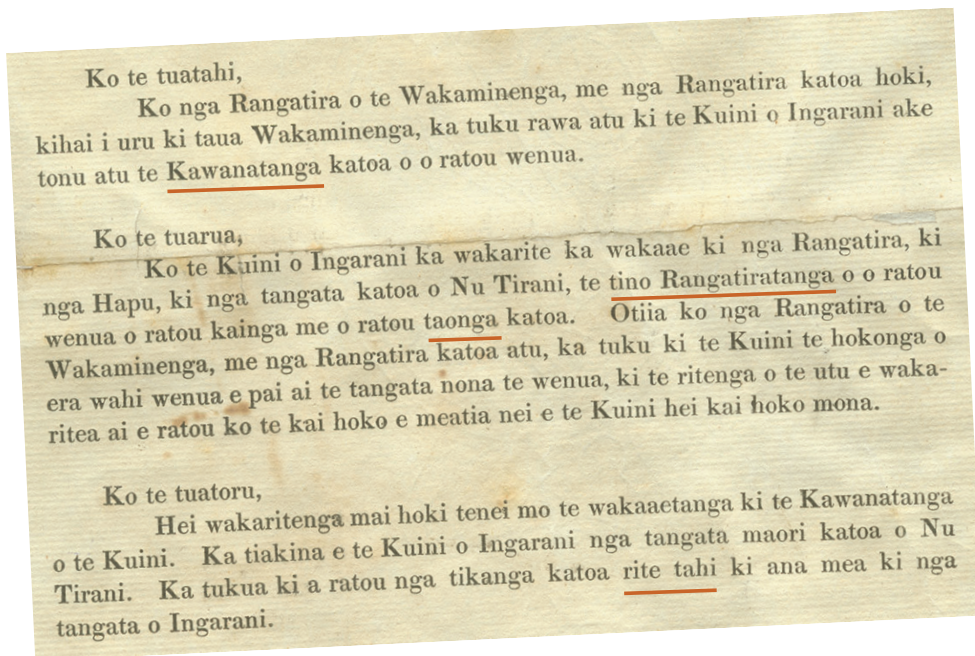

He tika he teka rānei! Pānuihia ēnei rerenga 10 mō te Tiriti o Waitangi, ā, tāporowhitahia mehemea he tika, he teka rānei.

Kei raro iho nei ngā whakautu e takoto huripoki ana – heoi, kua e tirohia, kia oti rā anō i a koe!

1. He mea tuhi te Tiriti o Waitangi ki te reo Māori i te tuatahi, kātahi ka whakapākehātia.

TIKA TEKA

2. He mea i oti te whakamāori o te Tiriti o Waitangi i te pō kotahi.

TIKA TEKA

3. Kotahi anake te Tiriti i hainatia ai e te katoa.

TIKA TEKA

4. He mea haina te Tiriti nā ngā rangatira Māori katoa me ngā kanohi o te Karauna i te 6 o Pēpuere, 1840.

TIKA TEKA

5. He ōrite te kōrero o te Tiriti reo Māori ki te Tiriti reo Pākehā.

TIKA TEKA

6. I te tau 1833 ko James Busby te Rehireneti tuatahi o Piritana o Nu Tireni.

TIKA TEKA

7. Neke atu i te 500 ngā rangatira i hainatia te Tiriti o Waitangi, tae atu hoki ki ngā rangatira wāhine e 13.

TIKA TEKA

8. Kotahi anake te putanga o te Tiriti he mea tuhi ki te reo Pākehā. Nō muri i te hainatanga, ka puritia ki roto pouaka rino i tētahi whare o Tāmaki Makarau, i te tau 1841 ka pau taua whare i te ahi. Ka whakaorangia, ā, i te tau 1865 ka tonoa ki Pōneke ki reira pouaka taongatia ai. Nō te tau 1908 ka kinohia e te wai, ka wāhi kaingatia e te kiore!



TIKA TEKA

9. E iwa ngā putanga tuatahi o te Tiriti e mau tonu ana.

TIKA TEKA

10. He mea pupuri ngā putanga tuatahi ki Te Papa.

TIKA TEKA